

Tools Required

- 4 ft. level
- Hammer
- Hammer drill
- Misc. screwdriver bits
- Hacksaw
- Misc. drill bits, including 4mm (5/32") & 8mm (5/16")
- 6mm (1/4") masonry bit
- 11mm (7/16") wrench
- 13mm (1/2") wrench
- Chalkline
- 152mm (6") shim block
- 6-lobe driver bit for upper hinge pin
- Tape measure

M E T A L

HEADRAIL BRACED ELITE INSTALLATION MANUAL



General Notes

The following installation instructions are based on the most common unit arrangement. Other arrangements will be encountered, i.e. units contained between two walls or between two freestanding panels.

For dimensional information, refer to your plan layout and dimensional details. Note in particular the relationship of the panels to the pilasters (panels do not necessarily fall on the centerline of the pilaster).

Varying site conditions can affect the installation process. To effect a rigid and level installation, it is important for installers to be aware of and compensate for uneven floor and wall conditions.

These instructions are applicable to Elite Plus installations as well. Please note: Elite Plus toilet partitions incorporate larger doors (1829mm / 72" high) and panels (1930mm / 76" high). Channels are also larger to match.

It is the distributor's responsibility to supply end-users with maintenance and warranty information.

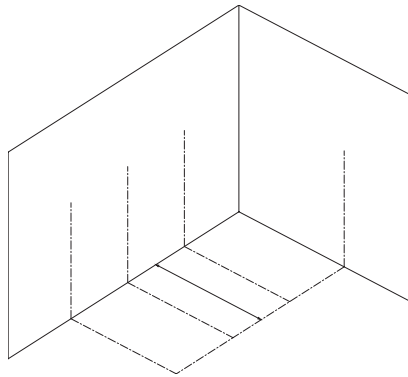

1

Establish Floor Bracket Locations

Establish front centerline by taking the overall compartment dimension and deducting 16 mm (5/8").

Use final layout drawings to determine locations.

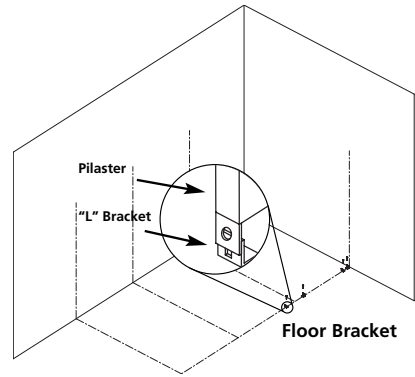

2

Fasten Floor Brackets

Drill holes for floor brackets 22mm (7/8") in from edge of pilaster locations as indicated on layout drawing.

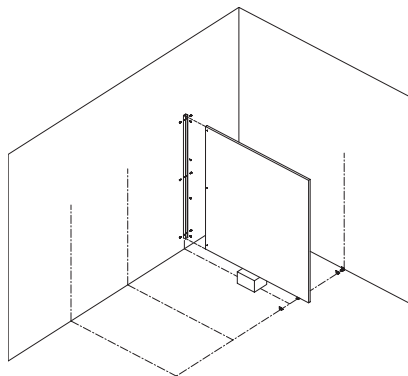

3

Erect Panel

Using your centerline locations, fasten wall channel to wall. The bottom of the channel should be 159mm (6 1/4") from floor.

Rest panel on 152mm (6") block and position in channel, leaving 13mm (1/2") clearance between wall and panel. Drill one hole through top of channel and fasten.

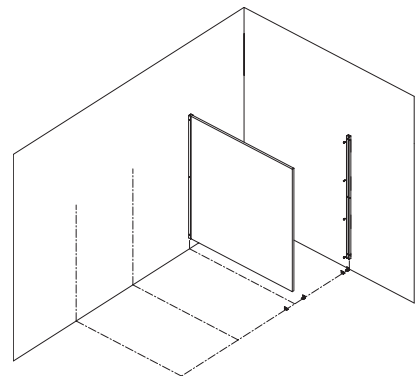

4

Place Pilaster Channel

Fasten channel to wall at centerline. Bottom of channel should be 159mm (6 1/4") from floor.

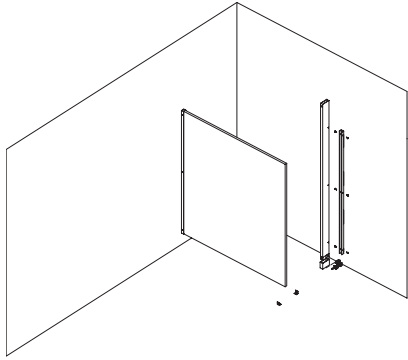

5

Erect Wall Pilaster

Slide shoe onto pilaster. Position pilaster in pilaster channel and over floor brackets. Install floor bracket hardware and leveling device, plumb pilaster, and tighten. Attach pilaster to channel.

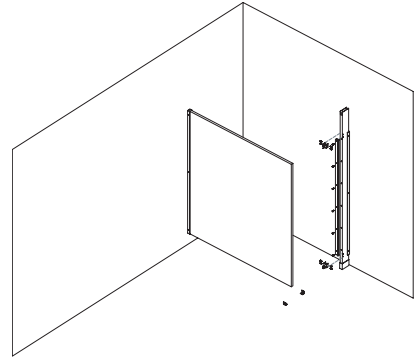

6

Prepare Pilaster For Door

Fasten upper and lower hinges to wall pilaster.

Place hinge side filler between hinges, pre-drill pilaster with 4mm (5/32") pilot holes and install fasteners.

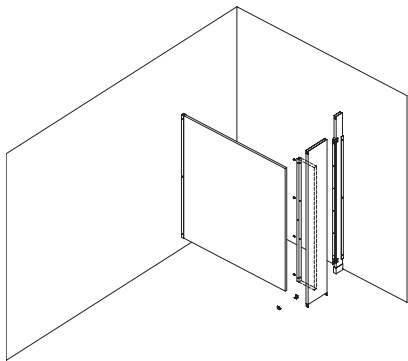

7

Fasten Channel To Pilaster

Place next pilaster on floor brackets and mark center line of panel on the back. Bottom of channel should be 159mm (6 1/4") from floor. Using the channel as a template, mark drill holes.

Remove pilaster from floor brackets and fasten channel.

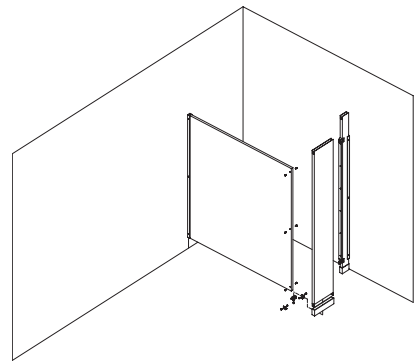

8

Erect Pilaster

Slide shoe onto pilaster. Insert leveling device and position pilaster on floor brackets (do NOT tighten yet) with channel engaging panel.

Drill one hole through top of channel and fasten.

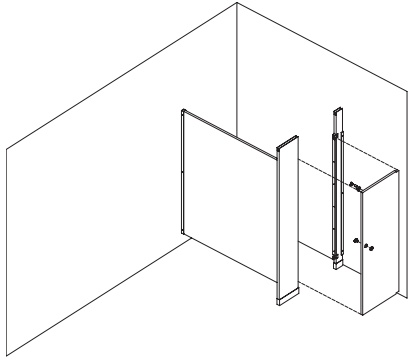

9

Prepare Door For Hanging

Insert female cam in the door.
Install latch and coat hook/bumper.

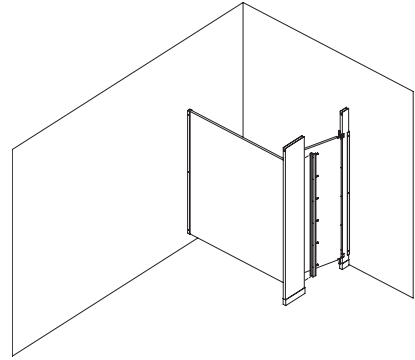

10

Hang Door

Insert male cam into bottom hinge and lower door onto it. Install threaded upper hinge pin. To set doors at the required angle, loosen the nut of the male cam assembly, set door at required angle, and tighten nut.

Place continuous stop on pilaster, ensuring the top lines up with the locking bar seam on top of the door. Pre-drill pilaster with 4mm (5/32") pilot holes and install fasteners.

At this stage, you may want to pre-install headrail (without fastening) to assist in lining up/spacing pilasters.

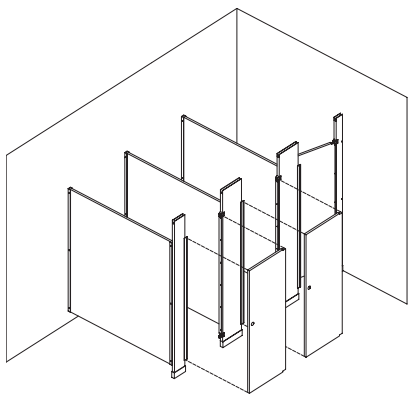

11

Erect Remaining Compartments

Ensure all pilasters are fastened to floor brackets and repeat steps 3-10 (as necessary) for all remaining compartments.

Note: Hadrian recommends installing one compartment (including door) at a time.

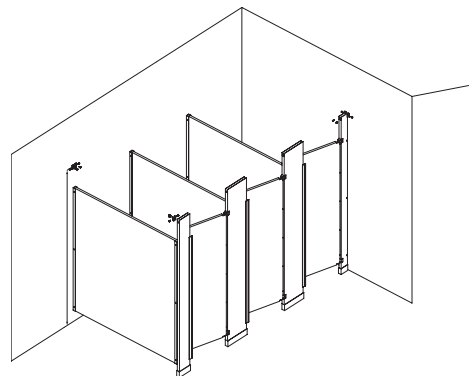

12

Secure Headrail Brackets

Fasten headrail brackets to wall approximately 2070mm (81.5") above the floor (some adjustment may be necessary due to varying floor conditions).

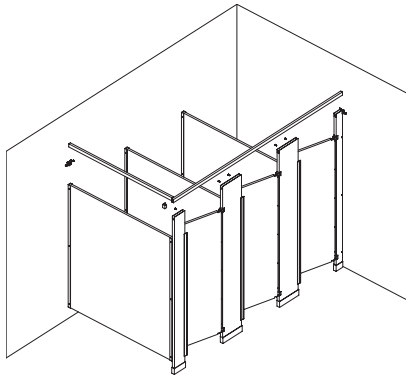

13

Place Headrail

Place headrail into tops of pilasters and slide into headrail brackets.

Fasten headrail to pilasters (screws on inside of compartment) and to headrail wall brackets. Install headrail end cap if required.

Adjust leveling devices to level all compartment components and tighten. Drill all remaining panel holes and fasten to brackets.



Optional Item

Continuous Hinge
Replaces conventional hinge and hinge filler

Contact Hadrian:

**IN CANADA & AREAS
OTHER THAN USA:**
Hadrian Manufacturing Inc.,
965 Syscon Road,
Burlington, ON L7L 5S3
tel: 905-333-0300
fax: 905-333-1841
CAN toll free fax: 1-888-817-7701

IN THE USA:
Hadrian Inc.,
7420 Clover Ave.,
Mentor, OH 44060
tel: 440-942-9118
fax: 440-942-9618
USA toll free fax: 1-800-536-1469