

## Powder Coated - Headrail Braced ELITE PLUS SERIES Metal Toilet Partitions

### Material Specification

#### 1 . 0 1 Construction

Doors, Panels and Pilasters shall be constructed of two sheets of panel flatness zinc-coated galvaneal steel, ASTM A653 GR33, laminated under pressure to a honeycomb core for sound deadening and rigidity. Formed edges to be welded together and inter-locked under tension with a roll-formed oval crown locking bar, mitred, welded and ground smooth at the corners. Honeycomb to have a maximum 25mm (1") cell size.

#### 1 . 0 2 Doors

Shall be 1816mm (71.5") high and 25mm (1") thick with cover sheets not less than 0.8mm (.030").

#### 1 . 0 3 Panels

Shall be 1918mm (75.5") high and 25mm (1") thick with cover sheets not less than 0.8mm (.030").

#### 1 . 0 4 Pilasters

Shall be 32mm (1.25") thick with cover sheets not less than 0.9mm (.036").

#### 1 . 0 5 Headrail

Shall be 25mm (1") by 41mm (1.625") extruded anodized aluminum with anti-grip design. Wall thickness to be 1.5mm (.060") and shall be securely attached to wall and pilasters with manufacturer's fittings in such a way as to make a strong and rigid installation. All joints in headrails shall be made at a pilaster.

#### 1 . 0 6 Pilaster Fastening Method

Pilasters shall be securely and rigidly fastened to the floor and fitted with a jack levelling screw for vertical adjustment. The floor fastening shall be concealed and protected by a 102mm (4") high, die-formed stainless steel pilaster shoe.

#### 1 . 0 7 Hardware & Fittings

All panel and pilaster brackets and all door hardware shall be chrome plated zinc die castings. Fasteners are zinc plated 12 x 1-3/4" and 12 x 5/8" TR-27 6-lobe security screws. Doors shall be equipped with gravity type hinges mounted on upper and lower pilaster hinge brackets. Door hinges shall be wrap-around style and adjustable to permit the door to come to rest at any position when not latched. Threaded upper hinge pin shall have a metal core and self lubricating nylon sleeve to ensure smooth, quiet operation. Each door to be fitted with a combined coat hook and bumper and a concealed latch, with face mortised flush with edge strip of door. A full length continuous stop and hinge side filler eliminate all sightline gaps between pilasters and doors.

#### 1 . 0 8 Finish

All sheet metal to be thoroughly cleaned, phosphated and finished with a high performance powder coating, baked on to provide a uniform smooth protective finish. Color shall be as selected from Hadrian's color card.

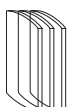

## Powder Coated - Headrail Braced ELITE PLUS SERIES Metal Toilet Partitions

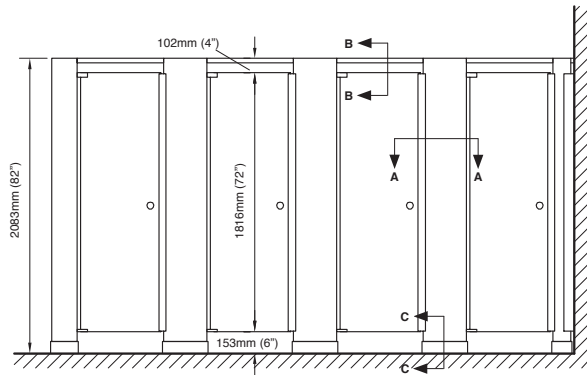

front elevation

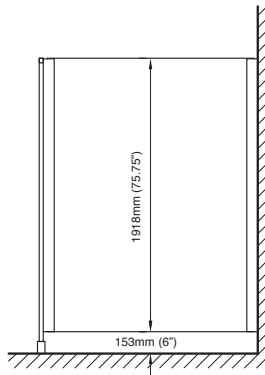

side elevation

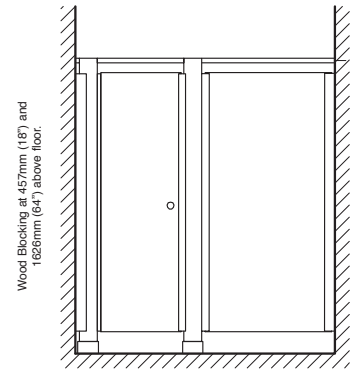

alcove elevation

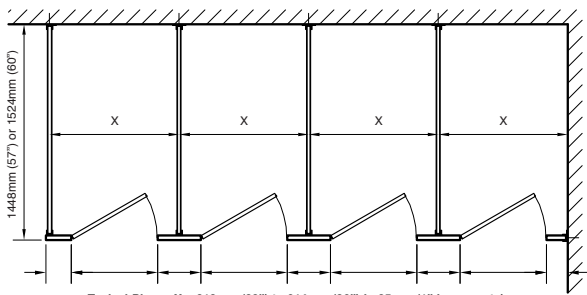

plan

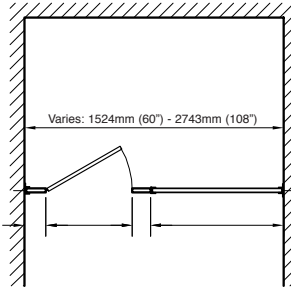

alcove plan

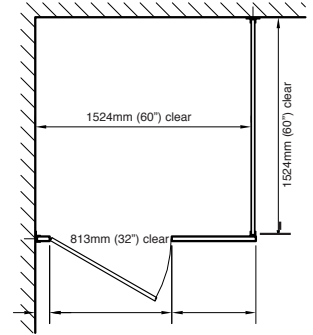

barrier-free plan

Headrail braced Elite Plus toilet partitions cannot be mounted 229mm (9 inches) above the floor as required by ADA, and therefore are not suitable for installations where ADA requirements are enforced.

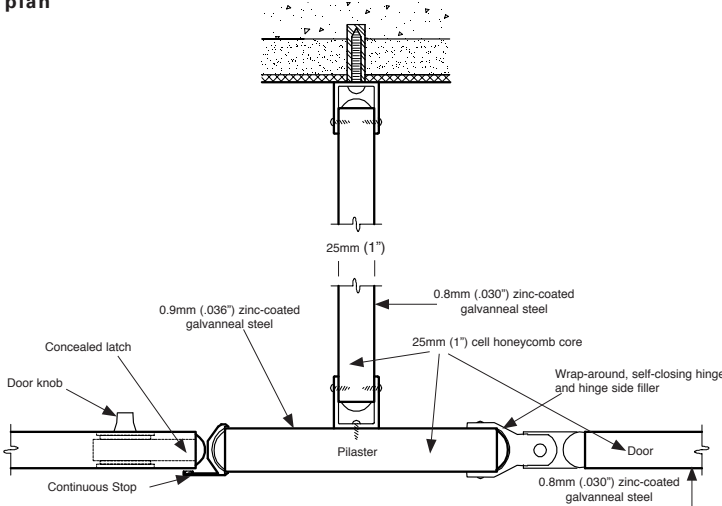

plan detail A-A

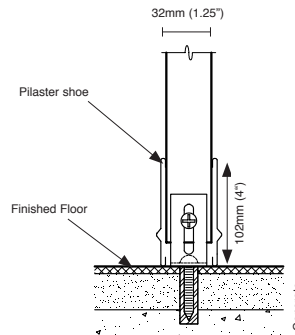

section detail C-C

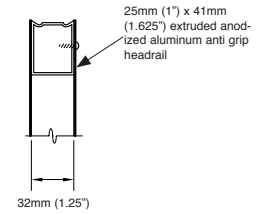

section B-B

### Important Note:

Refer to final drawings for wood blocking information. Wood blocking is critical to ensure a rigid installation.

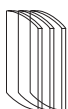

Hadrian Manufacturing Inc., 965 Syscon Road, Burlington, ON, Canada, L7L 5S3

Hadrian Inc.,

www.hadrian-inc.com

7420 Clover Avenue, Mentor, OH, U.S.A., 44060

Tel: (905) 333-0300

Tel: (440) 942-9118

Fax: (905) 333-1841

Fax: (440) 942-9618