



SOLID PLASTIC
TOILET PARTITIONS

hadrian®

SOLID PLASTIC

TOILET PARTITIONS

BUILT TO LAST

Hadrian's solid plastic toilet partitions are made from durable high density polyethylene (HDPE) material and are the ideal choice for high abuse facilities such as schools, stadiums, parks and airports. Hadrian's partitions are designed to stand strong and overcome abuse. They will not delaminate, dent, flake, crack or break!

CERTIFIED CLASS B OR NFPA 286 MATERIAL

Hadrian offers a full range of certified CLASS B colors that meet the requirements for ASTM E 84. A selection of NFPA 286 compliant colors are available at an upcharge.

SOLID CORE WITH NO AIR POCKETS

Hadrian's plastic material features a solid core that does not contain foaming agents, which can cause the formation of air pockets.

EASY TO MAINTAIN

From a maintenance point of view, nothing could be easier! Hadrian's solid plastic partitions practically take care of themselves, making them an ideal choice for harsh washroom environments.

GRAFFITI RESISTANT

Hadrian's solid plastic toilet partitions offer excellent graffiti resistance, allowing most graffiti to be removed.

THERE WHEN YOU NEED IT

Hadrian has the right lead times to meet any requirement. Solid plastic toilet partitions ship from stock within **5 business days**. With **99% on time deliveries**, Hadrian continues to set the standard for fast, reliable shipping.

INDUSTRY LEADING WARRANTY

With the best warranty in the business, Hadrian is confident that its partitions will stand the test of time. Hadrian's 25 year solid plastic warranty protects against breakage, delamination and corrosion.

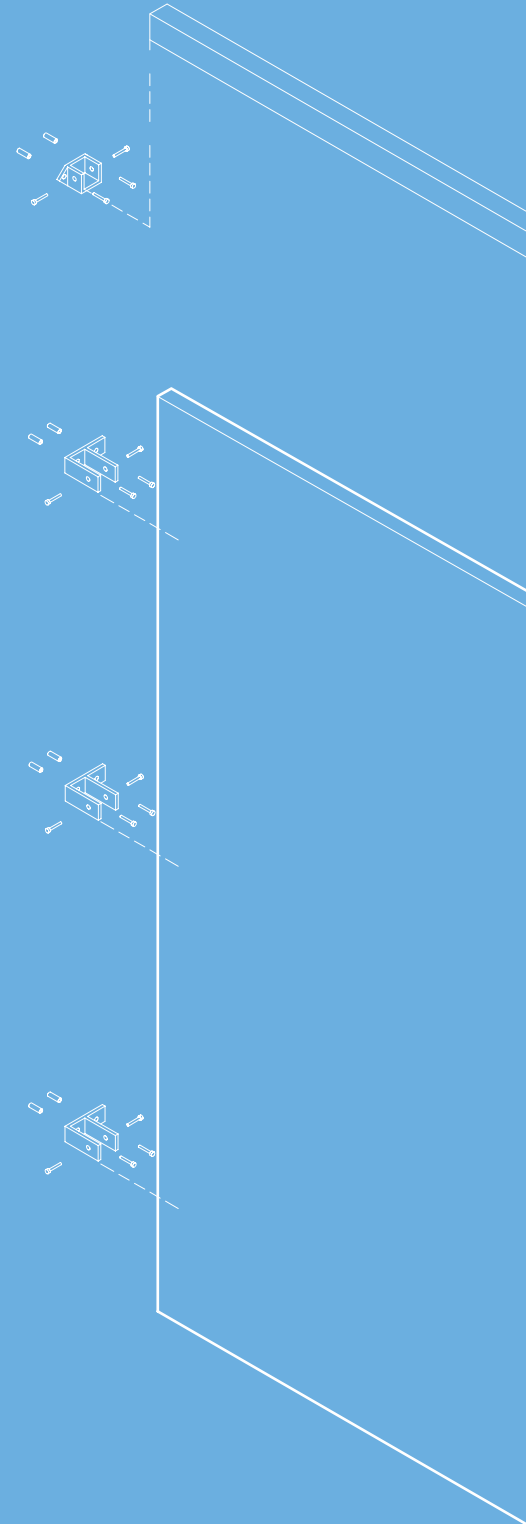

Styles

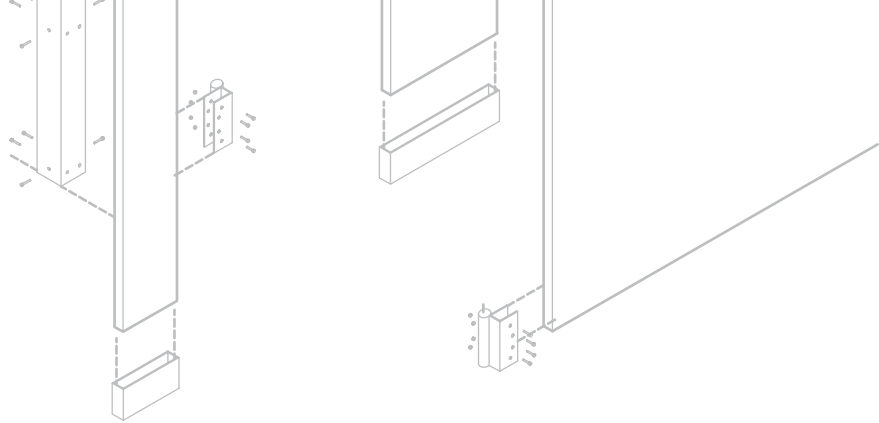

HEADRAIL BRACED

Headrail braced compartments are a great choice for virtually any facility. These units are especially recommended in heavy-use areas such as schools, institutions and industrial settings. The anti-grip top rail deters boisterous activity while ensuring a rigid and secure installation.



CEILING HUNG

Ceiling hung units present a clean, contemporary appearance. They permit quick, easy floor maintenance, especially when combined with wall-hung fixtures. Ceiling hung partitions are recommended for modernization where a drop ceiling or open span construction can be used.



FLOOR TO CEILING

Floor to ceiling units are extremely strong and resistant to abuse as they are securely connected to the floor, ceiling and walls. This configuration is ideal for high abuse areas and installations that require extra durability.

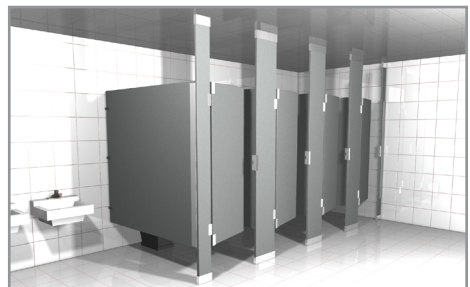

SCREENS

WALL MOUNTED SCREEN

- Simple and economical design
- Permits easy maintenance and floor cleaning

FLOOR MOUNTED SCREEN

- Supported by a 5" (127mm) floor mounted pilaster
- Great option for vandal prone installations

48" IPC compliant screens are also available.



Hadrian Green

Since its founding in 1983, Hadrian has been an environmentally responsible corporate citizen. We take special care with regard to the environment so you can feel good about choosing Hadrian products!



ENVIRONMENTALLY RESPONSIBLE

RECYCLED CONTENT

Hadrian's solid plastic colors all have a minimum pre-consumer recycled content of 30%.

LESS MATERIAL

In addition to having excellent recycled content, the long lifespan of plastic means that less material is used over time as facilities do not need to replace compartments every few years.

PACKAGING MATERIALS

Hadrian's hardware boxes are made from 100% recycled materials and our triple-ply corrugated "Jumbo" shipping container (USA) is 100% recyclable.



BMO FIELD - TORONTO, ONTARIO
200 HEADRAIL BRACED SOLID PLASTIC TOILET PARTITIONS

© EDWARD CHAMBERLAIN/EMPORIS

Hardware

Hadrian's solid plastic toilet partitions are available with a variety of hardware options to meet the design challenges of any washroom environment.

ALUMINUM HARDWARE (STANDARD)

- Heavy-duty aluminum 8" (203mm) round barrel hinges
- 6" (152mm) aluminum stop and keeper
- Black anodized latch with emergency access feature
- Full height aluminum channels at panel to pilaster connection
- Three heavy-duty aluminum brackets at panel to wall and pilaster to wall connections
- #4 brushed stainless steel shoes

* Full height aluminum channels at all connections are available as an option.



STAINLESS STEEL HARDWARE

- Full height stainless steel channels at panel to pilaster, panel to wall, and pilaster to wall connections
- Stainless steel continuous hinge
- Stainless steel latch
- Stainless steel stop and keeper
- #4 brushed stainless steel shoes



CONTINUOUS HINGE

Hadrian's heavy-duty 14-gauge continuous hinge is a great choice for heavy-use facilities such as schools and institutions. This 54" (1372mm) high stainless steel hinge covers the full height of the door and features a stainless steel hinge pin. Fastened to both the door and the pilaster with 6-lobe security head stainless steel through-bolts, the continuous hinge is a true heavy-duty option. As an added bonus, this item also acts as a no-sightline feature on the hinge side of the door.

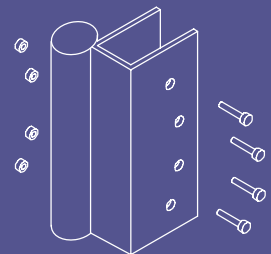

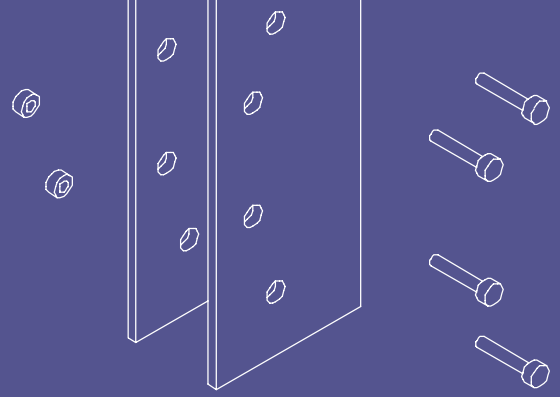
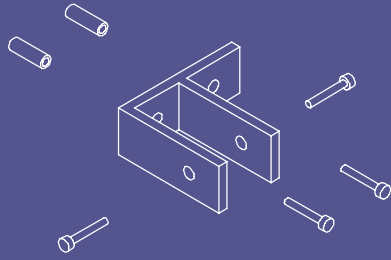

INTEGRAL HINGE

Hadrian's integral hinge system projects a clean, uncluttered appearance. The hinge pin and bottom cam are recessed into the door and pilaster to eliminate the need for exposed fasteners on the hinge side. Inconspicuous and virtually maintenance-free, the integral hinge is a great alternative to Hadrian's standard wrap-around offering. Integral hinge is available for headrail braced style only.

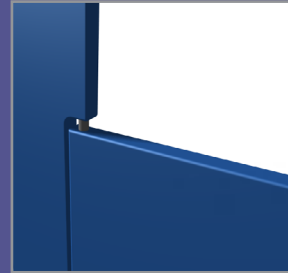

HEADRAIL

Hadrian's easy-to-install cap-over headrail ensures a rigid finished installation. For joining two pieces together, the headrail system features a convenient snap-fit design that does not require extra fasteners.

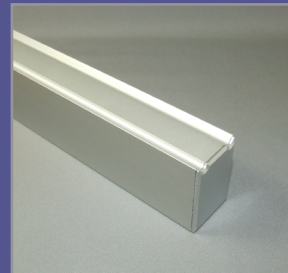

SHOES

Durable and easy to maintain, Hadrian's 3" (76mm) high stainless steel anchor shoes look great and make installation easy. Ceiling hung and floor to ceiling partitions use 4" (102mm) high stainless steel sleeve shoes only.

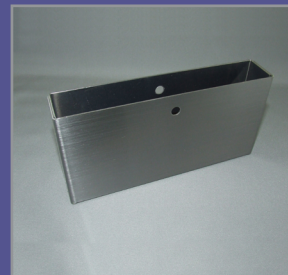

FASTENERS

Fasteners are theft-proof 6-lobe security head stainless steel screws to deter vandalism.

hadrian®

Hadrian prides itself on being a professional and friendly company that is easy to deal with. We make it a priority to spend time getting to know our customers and work with them to meet the challenges of their specific market. Our local representatives ensure Architect, Interior Designer, Specification Writer, Government Planner, School Official and End-User sales coverage while also expeditiously addressing field support needs and jobsite concerns.

