

## Powder Coated - Headrail Braced ELITE SERIES Metal Toilet Partitions

### Material Specification

#### 1 . 0 1 Construction

---

Doors, Panels and Pilasters shall be constructed of two sheets of panel flatness zinc-coated galvaneal steel, ASTM A653 GR33, laminated under pressure to a honeycomb core for sound deadening and rigidity. Formed edges to be welded together and inter-locked under tension with a roll-formed oval crown locking bar, mitred, welded and ground smooth at the corners. Honeycomb to have a maximum 25mm (1") cell size.

#### 1 . 0 2 Doors

---

Shall be 1613mm (63.5") high and 25mm (1") thick with cover sheets not less than 0.8mm (.030").

#### 1 . 0 3 Panels

---

Shall be 1613mm (63.5") high and 25mm (1") thick with cover sheets not less than 0.8mm (.030").

#### 1 . 0 4 Pilasters

---

Shall be 32mm (1.25") thick with cover sheets not less than 0.8mm (.030").

#### 1 . 0 5 Headrail

---

Shall be 25mm (1") by 41mm (1.625") extruded anodized aluminum with anti-grip design. Wall thickness to be 1.5mm (.060") and shall be securely attached to wall and pilasters with manufacturer's fittings in such a way as to make a strong and rigid installation. All joints in headrails shall be made at a pilaster.

#### 1 . 0 6 Pilaster Fastening Method

---

Pilasters shall be securely and rigidly fastened to the floor and fitted with a jack levelling screw for vertical adjustment. The floor fastening shall be concealed and protected by a 102mm (4") high, die-formed stainless steel pilaster shoe.

#### 1 . 0 7 Hardware & Fittings

---

All panel-to-wall, panel-to-pilaster and pilaster-to-wall connections shall be made with full height continuous channels. Door hardware shall be chrome plated zinc die castings. Fasteners are zinc plated 12 x 1-3/4" and 12 x 5/8" TR-27 6-lobe security screws. Doors shall be equipped with gravity type hinges mounted on upper and lower pilaster hinge brackets. Door hinges shall be wrap-around style and adjustable to permit the door to come to rest at any position when not latched. Threaded upper hinge pin shall have a metal core and self lubricating nylon sleeve to ensure smooth, quiet operation. Each door to be fitted with a combined coat hook and bumper and a concealed latch, with face mortised flush with edge strip of door. A full length continuous stop and hinge side filler eliminate all sightline gaps between pilasters and doors.

#### 1 . 0 8 Finish

---

All sheet metal to be thoroughly cleaned, phosphated and finished with a high performance powder coating, baked on to provide a uniform smooth protective finish. Color shall be as selected from Hadrian's color card.

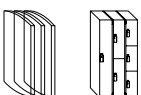

## Powder Coated - Headrail Braced ELITE SERIES Metal Toilet Partitions

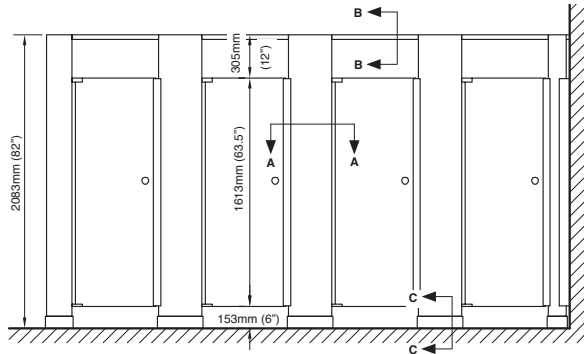

front elevation

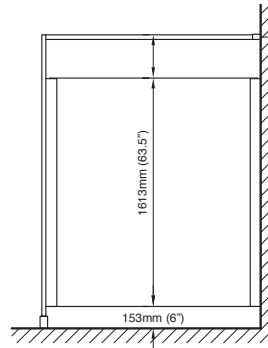

side elevation

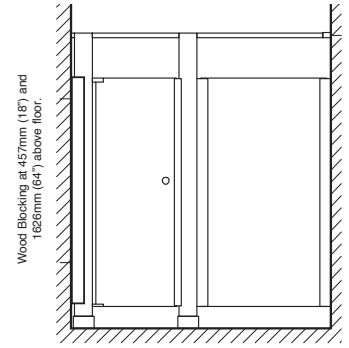

alcove elevation

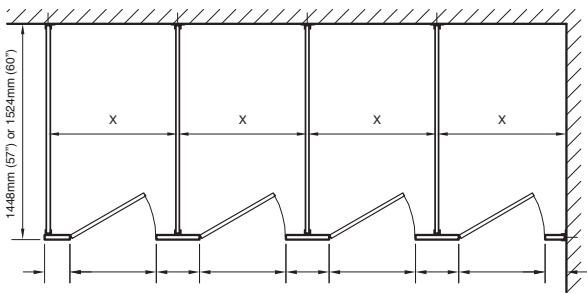

Typical Plan: X = 813mm (32") to 914mm (36") in 25mm (1") increments

plan

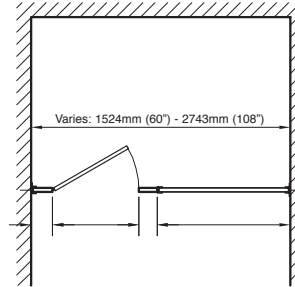

alcove plan

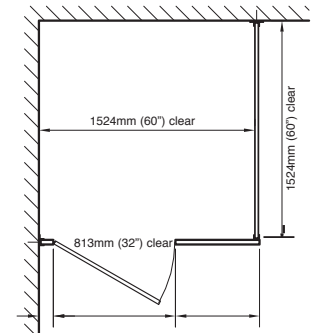

barrier-free plan

Option: Barrier-free units can be mounted 229mm (9") above the floor upon request.

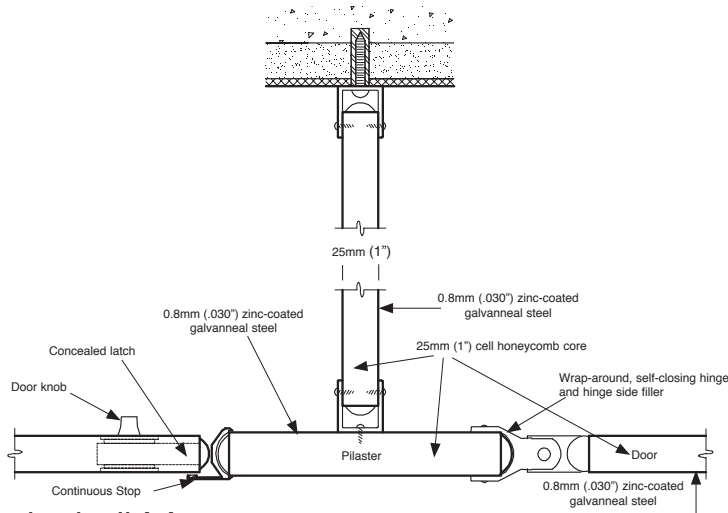

plan detail A-A

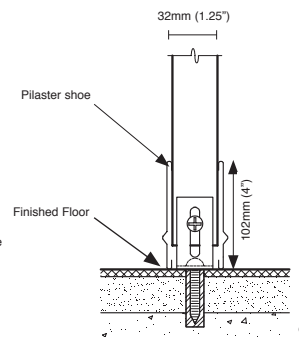

section detail C-C

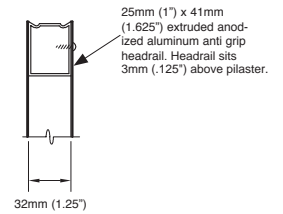

section B-B

### Important Note:

Refer to final drawings for wood blocking information. Wood blocking is critical to ensure a rigid installation.



**Hadrian Manufacturing Inc.**, 965 Syscon Road, Burlington, ON, L7L 5S3 • Tel: (905) 333-0300 • Fax: (905) 333-1841

**Hadrian Inc.**, 7420 Clover Avenue, Mentor, OH, 44060 • Tel: (440) 942-9118 • Fax: (440) 942-9618

**Hadrian Inc.**, 3602 West Washington Street, Suite 200, Phoenix, AZ 85009 [www.hadrian-inc.com](http://www.hadrian-inc.com)