

hadrian® STANDARD - Solid Plastic Toilet Partitions - Headrail Braced

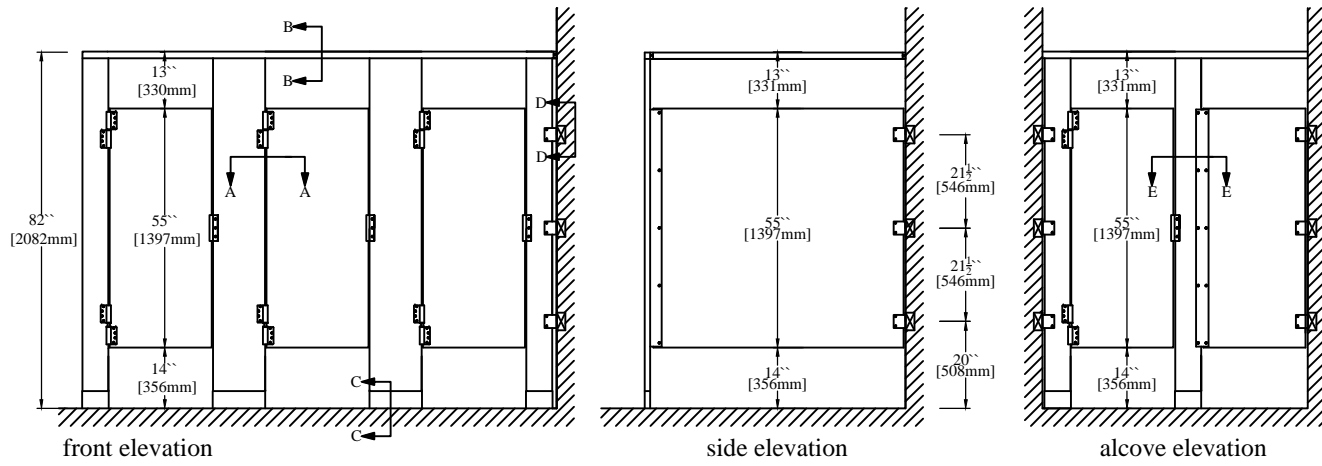

32mm (1.25") x 44mm (1.75")
extruded anodized aluminum
anti-grip headrail.

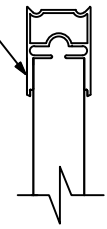

plan detail B-B

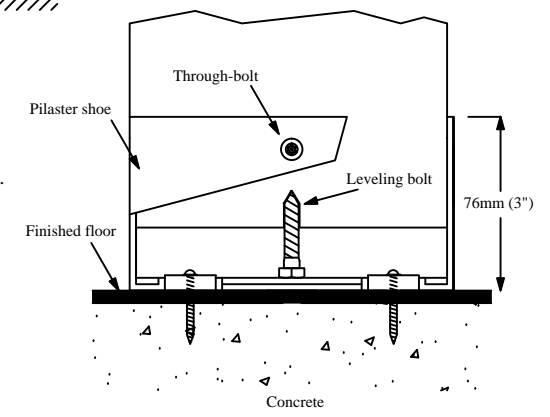

plan detail C-C

Important Notes:
Refer to final drawings for wood blocking information.
Wood blocking is critical to ensure a rigid installation.

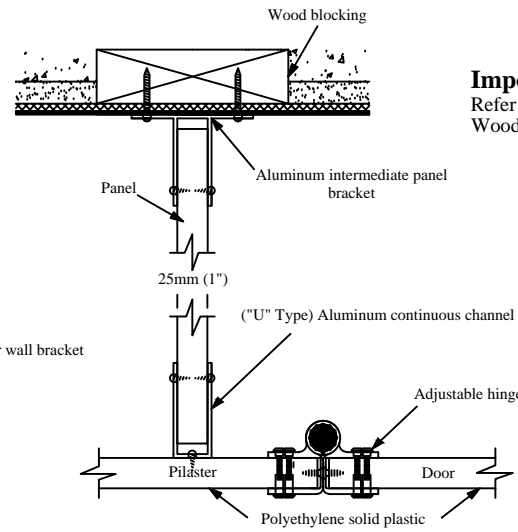

plan detail A-A

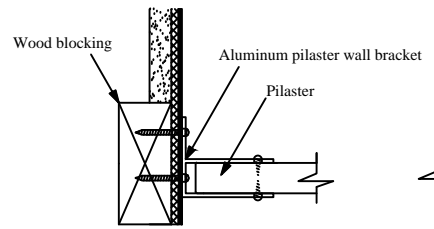

plan detail D-D

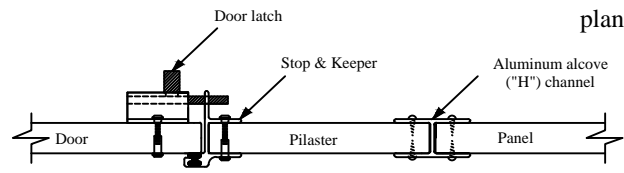

plan detail E-E

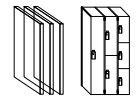

Hadrian Manufacturing Inc. 965 Syscon Road, Burlington, ON, Canada, L7L 5S3 • Tel: (905) 333-0300 • Fax (905) 333-1841
Hadrian Inc., 7420 Clover Avenue, Mentor, OH, U.S.A., 44060 • Tel: (440) 942-9118 • Fax (440) 942-9618
www.hadrian-inc.com